

Inserti

Power Bits / *Embouts*



Taglio

Slotted / Fente

ISO 2380
DIN 3127

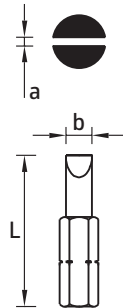

a mm	b mm	CODE	L mm	g
0,5	3	AC3I	25	2
0,6	3,5	AC3.5I	25	3
0,6	4	AC4I	25	4
0,6	4,5	AC4.5I	25	6
0,8	5,5	AC5.5I	25	8
1,2	6,5	AC6.5I	25	10
1,2	8	AC8I	25	12
1,6	10	AC10I	25	16

Phillips

ISO 2351-2
DIN 3128

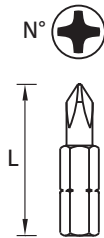

N°	CODE	L mm	g
0	AC0X	25	2
1	AC1X	25	4
2	AC2X	25	4
3	AC3X	25	4
4	AC4X	32	5

PZD

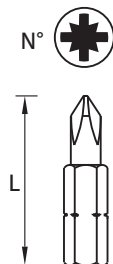

N°	CODE	L mm	g
1	AC1PZ	25	4
2	AC2PZ	25	4
3	AC3PZ	25	6



Esagoni Cavi

Allen-Head / Embouts

ISO 2351-3
DIN 7426

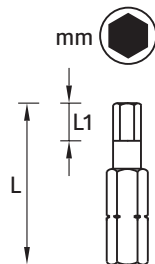

mm	CODE	L1 mm	L mm	g
2	AC2M	4	25	3
2,5	AC2.5M	4	25	3
3	AC3M	5	25	4
4	AC4M	6	25	4
5	AC5M	7,5	25	6
6	AC6M	9	25	6
8	AC8M	12,5	25	8
10	AC10M	12,5	25	8

TX

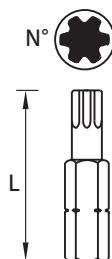

N°	CODE	L mm	g
10	AC10T	25	5
15	AC15T	25	5
20	AC20T	25	5
25	AC25T	25	6
27	AC27T	25	6
30	AC30T	25	6
40	AC40T	35	6

Porta Inserti

Bit Holder / Porte Embout



□	○	CODE	Ø1 mm	Ø2 mm	L mm	g	○
1/4"	1/4" - D	AAD	12	13	26	16	A
3/8"	1/4" - D	BAD	14	19	31	35	B

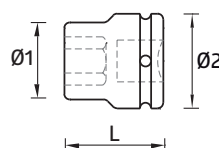

I valori possono variare senza preavviso - I valori di peso sono indicativi.

Values may change without prior notice - Weight values are approximate. / Les valeurs peuvent changer sans préavis - Les valeurs de poids sont indicatives.



FORMA "E"
FORM "E" / FORM "E"

1/4"

ATTACCO ESAGONALE

HEXAGONAL SHANK / HEXAGONE CONDUCTEUR

ISO 1173 - DIN 3126



Taglio

Slotted / Fente

ISO 2380
DIN 3127

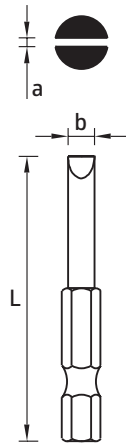

a mm	b mm	CODE	L mm	g
0,5	3	AE3I	50	8
0,6	3,5	AE3.5I	50	8
0,6	4	AE4I	50	8
0,6	4,5	AE4.5I	50	10
0,8	5,5	AE5.5I	50	12
1,2	6,5	AE6.5I	50	14
1,2	8	AE8I	50	16

Phillips

ISO 2351-2
DIN 3128

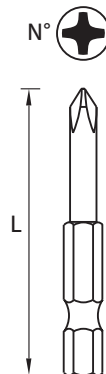

N°	CODE	L mm	g
1	AE1X	50	10
2	AE2X	50	10
3	AE3X	50	12

PZD

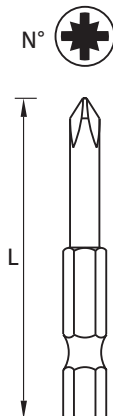

N°	CODE	L mm	g
1	AE1PZ	50	8
2	AE2PZ	50	12
3	AE3PZ	50	16

I valori possono variare senza preavviso - I valori di peso sono indicativi.

Values may change without prior notice - Weight values are approximate. / Les valeurs peuvent changer sans préavis - Les valeurs de poids sont indicatives.

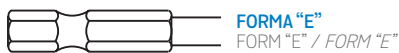

Esagoni Cavi

Allen-Head / Embouts

ISO 2351-3
DIN 7426

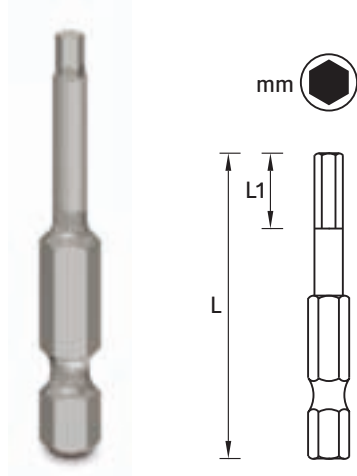

mm	CODE	L1 mm	L mm	g
2	AE2M	4	50	10
2,5	AE2.5M	4	50	10
3	AE3M	5	50	12
4	AE4M	6	50	12
5	AE5M	7,5	50	12
6	AE6M	9	50	14
8	AE8M	12,5	50	16

TX

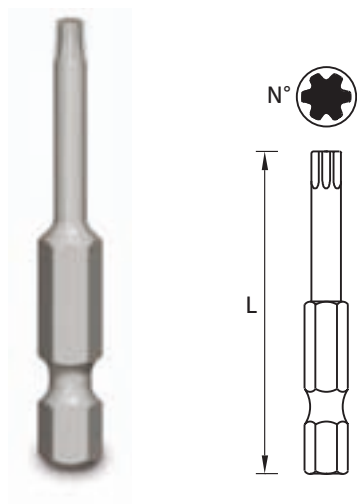

N°	CODE	L mm	g
10	AE10T	50	8
15	AE15T	50	8
20	AE20T	50	8
25	AE25T	50	10
27	AE27T	50	10
30	AE30T	50	10
40	AE40T	50	10

Mandrini a Sgancio Rapido

Quick Release Chucks / Mandrins à décrochement rapide



3/8"	1/4" - F	CODE	Ø1 mm	Ø2 mm	L mm	g	B
		BAF/CK	19	19	42	60	B

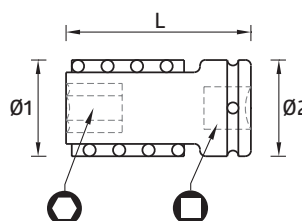

I valori possono variare senza preavviso - I valori di peso sono indicativi.

Values may change without prior notice - Weight values are approximate. / Les valeurs peuvent changer sans préavis - Les valeurs de poids sont indicatives.



FORMA "E"
FORM "E" / FORM "E"

1/4"
ATTACCO ESAGONALE
HEXAGONAL SHANK / HEXAGONE CONDUCTEUR
ISO 1173 - DIN 3126





Porta Inserti

Bit Holder / Porte Embout

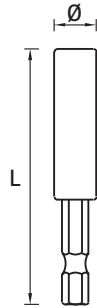
DIN 7427



 in	CODE	Ø mm	L mm	 g
1/4"	AEAD	11	60	26
1/4"	AEADMG*	11	60	36



* Con magnete
With magnet / Avec aimant

Adattatori

Adaptors / Adaptateurs

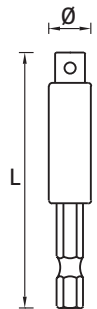
ISO 3317
DIN 7428





 in	CODE	Ø mm	L mm	 g
1/4"	AEA2	9	50	18
1/4"	AEA4	9	100	40
3/8"	AEB2	10	50	20
3/8"	AEB4	10	100	54

Bussole ad Insetto

Power Nut Setters / Douilles Embout

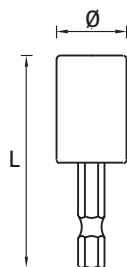
DIN 7424



 mm	CODE	Ø mm	L mm	 g
5	AE5	9	50	16
5,5	AE5,5	9,5	50	16
6	AE6	10	50	18
7	AE7	11	50	18
8	AE8	12	50	22
9	AE9	14	50	24
10	AE10	15	50	26

I valori possono variare senza preavviso - I valori di peso sono indicativi.

Values may change without prior notice - Weight values are approximate. / Les valeurs peuvent changer sans préavis - Les valeurs de poids sont indicatives.